

LS321

Multi-Laser Devices

User's Manual

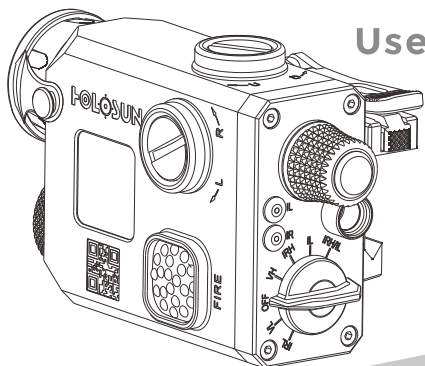

LS321R:
Red/IR Laser Pointer
IR Laser Illuminator
LS321G:
Green/IR Laser Pointer
IR Laser Illuminator



LASER RADIATION
DO NOT STARE INTO BEAM

www.holosun.com

1. GENERAL INFORMATION

1.1 SYSTEM DESCRIPTION

The LS321 is a Class IIIa laser device that features a Visible Laser Pointer for daylight or low light operations, an IR Laser Pointer for use with a NVD and an IR illuminator. The LS321 emits the highly collimated Visible Pointer and IR Pointer for precise aiming. The Visible Pointer, IR Pointer and IR Illuminator are co-aligned.

1.2 COMPONENT DESCRIPTION

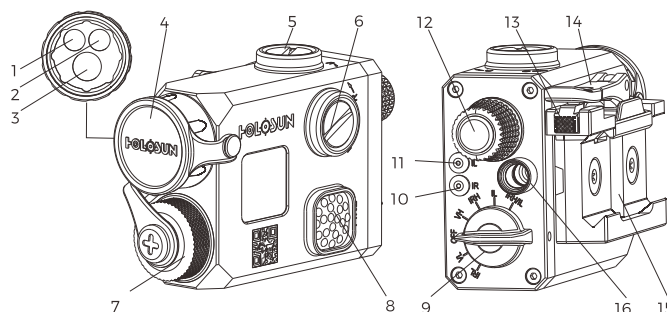

Fig 1

1

1	Visible Laser	6	Windage Adjuster	11	IR IL Indicator		
2	IR Pointer	7	Battery Cap	12	Focusing Knob		
3	IR Illuminator	8	Fire Switch	13	Handle Lock		
4	Protective Cover	9	Mode Selector	14	Slider	15	Bolt
5	Elevation Adjuster	10	IR Pointer Indicator	16	Remote Cable Switch		

1.3 PACKING

The package should contain the following items:

- LS321 Lasers Sight
- 1*CR123A Battery
- User manual
- Trox Tool

2. FEATURES

The Visible Pointer, IR Pointer and IR Illuminator are co-aligned so that the user could adjust three beams simultaneously via same adjuster.

The green laser is direct green laser that is more energy-saving, brighter, more stable than DPSS laser.

The LS321 features the low-battery indicator, and IR Pointer and IR Illuminator indicators.

Quick Release Mount.

Waterproofed Remote cable switch.

Aluminum housing with Micro arc oxidation finish.

The focus ranges from 95 to 210mrad and the knob locates at ocular side.

2

3. SPECIFICATIONS

Parameter		LS321G				LS321R			
Laser Sight	Wavelength(nm)	520	830	635	830				
	Output Power (mW)	Lo	Hi	Lo	Hi	Lo	Hi	Lo	Hi
		<1	<5	0.3	<0.7	<1	<5	0.3	<0.7
	FDA Class	II	IIIa	II	II	II	IIIa	II	II
Divergence(mrad)	0.6		0.5		0.6		0.5		
Laser illuminator	Wavelength(nm)	830							
	Output Power(mW)	<4							
	Divergence(mrad)	Adjustable: ≥95 - 210							
	FDA Class	IIIa							
Adjustment range	±50MOA								
Battery	CR123A×1								
Operating Temperature	-40°C-51°C								
Storage Temperature	-40°C-65°C								
Water Proof	Ip67								
Color housing	Desert Sand/ Matte Black								
Length:mm	92								
Width × height:mm	57×43								
Weight: (g)	245								

4. OPERATING INSTRUCTIONS

4.1 SAFTY SUMMARY

WARNING - LASER RADIATION



3

- DO NOT stare into the laser beams.
- DO NOT look into the laser beam through binoculars or telescopes.
- DO NOT point the laser beam at mirror- like surfaces.
- DO NOT shine the laser beam into other body's eyes.

SAFTY ALERTS

WARNING

DO NOT store LS321 with battery installed.

Ensure the Mode Selector is OFF before checking the Lens of LS321.

CAUTION

Identifies risk of damage to the equipment.

All the directions are given from the shooter's viewpoint.

DO NOT over-adjust the W&E adjuster by forcing them beyond their end of travel.

4

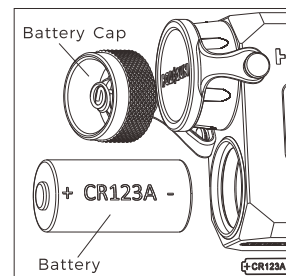

Fig 2

4.2 BATTERY INSTALLATION

1. Unscrew the battery cap in a CCW direction. Remove and properly discard the used battery.
2. Inspect the battery compartment for dirt, moisture and corrosion, and then clean the battery compartment if needed.
3. Inspect the O-ring seal on the battery cap to make sure that it is free of sand and dirt particles and that it has not been damaged.

4. Install the battery in a direction marked on the nearby housing and then screw the battery cap in a CW direction.
- LOW BATTERY INDICATOR :** When the LS321 is switch on either model V or mode IR, the flickering Visible Pointer or the IR Indicators represents the low battery situation.

4.3 MOUNTING INSTRUCTION

The repeatability accuracy is less than 2 MOA.

First Use:

1. Use screwdriver to loose the mount of LS321 in order to install the LS321 on the rail.
2. Open the handle lock and then load the LS321 on the pica tiny rail.
3. Latch the handle lock and use screwdriver to adjust the tightness.

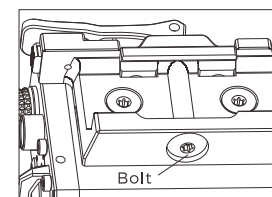

Fig 4

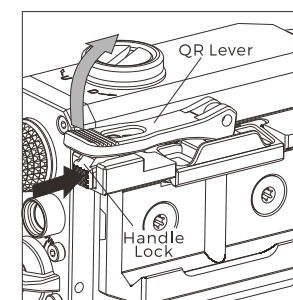

Fig 3

Repeat Use:

1. Open the handle lock and then load the LS321 on the pica tiny rail.
2. Latch the handle lock.

5

4.4 Mode Selector

The LS321 has 6 modes and is set at mode OFF. Please make sure the mode selector is at one of 6 modes and do not locate the mode selector at any position between two modes.

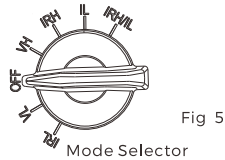

Fig 5

Mode	Description
IRL	Low power IR Pointer will be on when PRESS Fire Switch
VL	Low power Green Laser Pointer will be on when PRESS Fire Switch
OFF	No laser will be on when PRESS Fire Switch
VH	High power IR Pointer will be on when PRESS Fire Switch
IRH	High power IR Pointer will be on when PRESS Fire Switch
IL	High power IR Pointer and IR illuminator will be on
IRH/IL	IR Illuminator will be on when PRESS Fire Switch

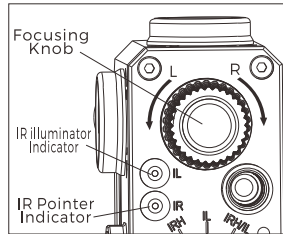

Fig 6

The "IR" indicator will be active if the IR pointer is on. The "IL" indicator will be active if the IR illuminator is on.

5. MAINTAIN

The LS321 is rugged, compact laser device that is designed to operate in severe environments. The exterior housing is made of aircraft grade aluminum and the other components are made of chemically resistant materials that will not be harmed by chemicals normally encountered during military operation. Operator maintenance is limited to the inspection and cleaning of the LS321 external surfaces, replacement of battery before each mission and removal of the battery after each mission.

6. WARRANTY

Holosun will furnish its standard form LIMITED WARRANTY in favor of its customers and the first end users of its products. The LS321 has a one year limited warranty on parts and workmanship from the date of purchase. The warranty is void if the serial number or the manufacturer's labels affixed to the product has been removed or if the product has been misused, modified, neglected or has been disassembled prior to return to manufacturer. To the maximum extent permitted by law, Holosun's election to repair or replace the device shall constitute the purchaser's sole remedy in the event of a defect.

4.5 SWITCH INSTRUCTION

After choose the output laser via Mode Selector Switch, uncover the lens cover and put it on the magnetic steel. Both Switch Button and Remote Cable Switch can be used to activate the laser under the chosen mode.

4.5.1 SWITCH BUTTON

OPERATION:

1) Momentary On Mode: Single press

the core of Switch Button and hold it, the laser will be activated and last until the Switch Button was released.

2) Continuous On Mode: Double press the Switch Button without holding, the laser will be activated and last 5 minutes and then automatically turn off. The user also can press Switch Button once to turn off the unit manually.

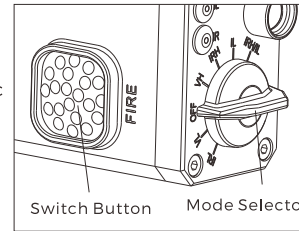

Fig 7

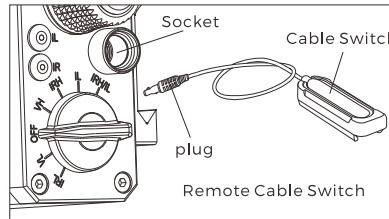

Fig 8

4.5.2 REMOTE CABLE SWITCH

INSTALLATION:

- 1) Uncover the socket cover.
- 2) Insert the plug of Remote Cable Switch into the socket after matching the interfaces of plug and socket
- 3) Screw the protective set of connection part.

7. NON-WARRANTY INFORMATION

Non-warranty repairs are subject to an evaluation fee. LS321 units that are not covered by the warranty will be tested and evaluated for failure. Customer permission and payment terms will be obtained prior to perform any repairs.

8. RETURN INSTRUCTIONS

○ For service, repair or replacement email:warranty@holosun.com, call 909-594-2888

○ Please provide the following information to assist technician to determine if the item is repairable:

1. Serial Number of the defective item.
2. Thorough description of the malfunction, defect or damage
3. An explanation as to how the malfunction, defect or damage occurred, if known.

(NOTE: If the technician determines that the item is under warranty or should be returned for repair, a Return Material Authorization (RMA) number will be provided.)

○ LS321 should be followed to prevent any additional damage:

1. Be sure that the is free of all contaminants such as dirt or any other foreign material.
2. Remove the battery.

OPERATION:

1) Momentary On Mode: Single press button of Remote Cable Switch and hold it, the laser will be activated and last until the Switch Button was released

2) Continuous On Mode: Double press the button without holding, the laser will be activated and last 5 minutes and then automatically turn off. The user also can press Switch Button once to turn off the unit manually.

4.6 WINDAGE & ELEVATION ADJUSTMENT ADJUSTOR

Adjuster	Position	Mark	Direction	Pointer Movement
Elevation Knobs	Top	U	CW	Up
		D	CCW	Down
Windage Knobs	Side	L	CW	Left
		R	CCW	Right

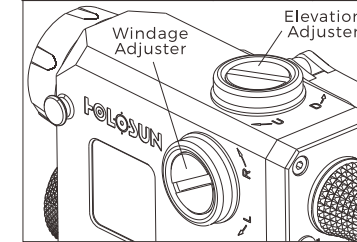

Fig9

ADJUSTMENT
Use wrench or coin to rotate the adjuster as needed according to the instruction table above.

3. Place the Exit Port Covers over each of the lenses.

4. Place the LS321 in the Shipping Case or Carrying Case if available. If the Shipping Case is not available, individually package each LS321 unit being returned in a suitable container.

Place the LS321 and a copy of the test report or detailed description of the failure in a suitable packing/shipping container. Mark the package with the RMA number. Ship the fastest, traceable, Please refer to www.holosun.com for current and complete warranty information.

LS321R/LS321G
Multi-Laser Devices

HOLOSUN

Holosun Technologies Inc.

Customer Service

www.holosun.com
(909) 594-2888
warranty@holosun.com